

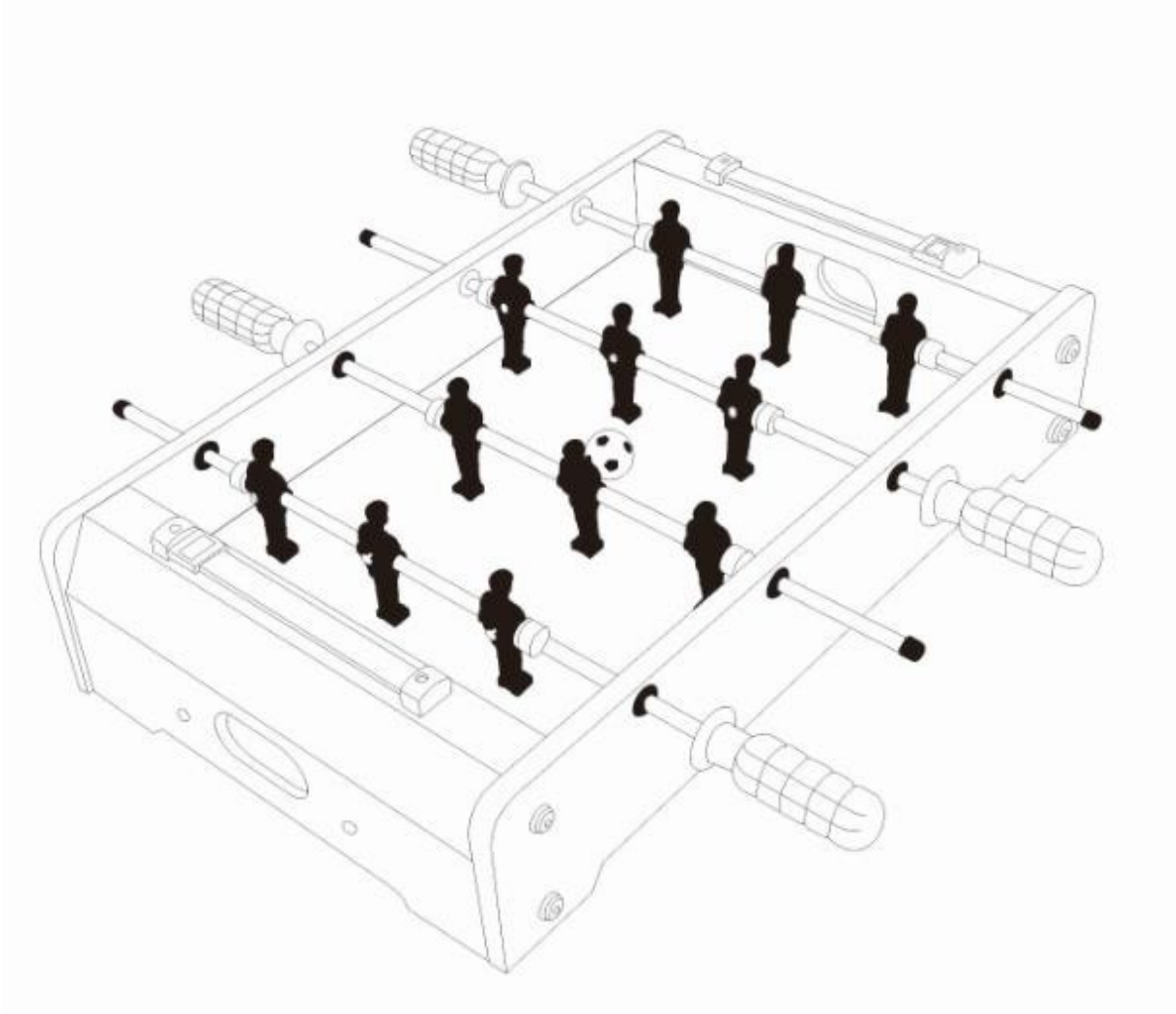

NÁVOD NA INŠTALÁCIU

Číslo výrobku: 4817



















Mielőtt hozzá kezdende az összeszereléshez ellenőrizze a mellékelt alkatrészeket, hogy hiánytalanul meg e vannak.
(Az alkatrészek mellékelve vannak a dobozban)

CAUTIONS!

Az összeszerelést felnőtt végezze, vagy legalábbis felnőtt felügyelete alatt!!!

SUBDIVIDES

PARTS:

Number		Qty	Number		Qty	
A1		x 2	E1		x 2	Home Team
A2		x 4	E2		x 2	T1
A3		x 4	E3		x 1	
B1		x 8	E4		x 2	x 1
B3		x 4	E5		x 8	Away Team
C1		x 1	E6		x 8	T3
			E7		x 2	
			E8		x 4	x 1
						T4
						
						x 1

KONTAKT

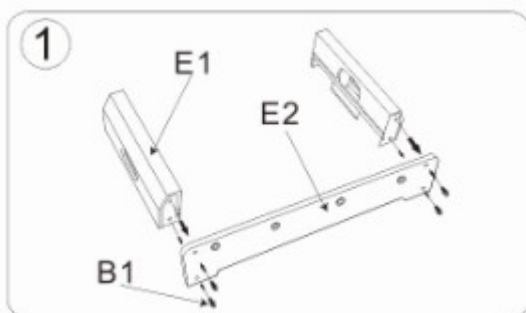

Dlhšiu stranu oviňte krátkymi stranami, ako je znázornené na obrázku.

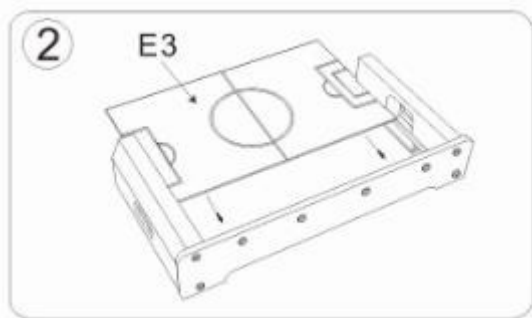

Potom vložte hernú dráhu podľa schémy.

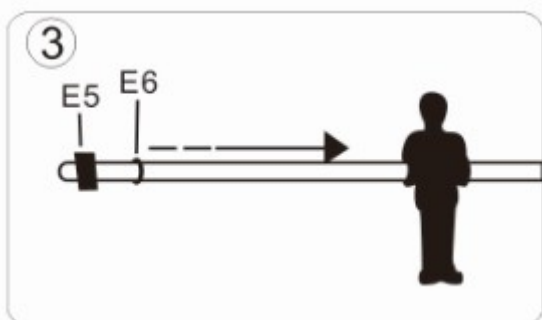

Posuňte 1 ks podložky E6 rovnou stranou smerom k prehrávaču a umiestnite ju na okraj druhej rukoväte. Potom túto operáciu dokončíte nasunutím podložky E5 aj gumy na rukoväte. Zatlačte podložku a gumu veľmi blízko k prehrávačom.

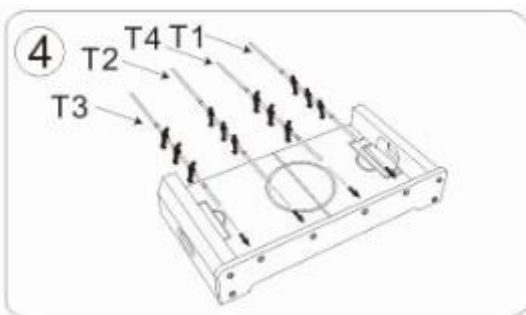

Zasuňte rukoväte do otvorov na dlhšej strane. Pozri obrázok.

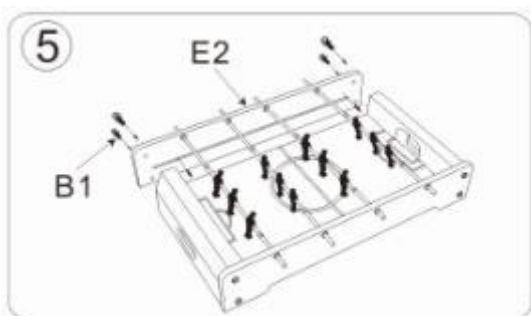

Potom pripevnite poslednú dlhú stranu k držadlám a nakoniec ju upevnite pomocou skrutiek.

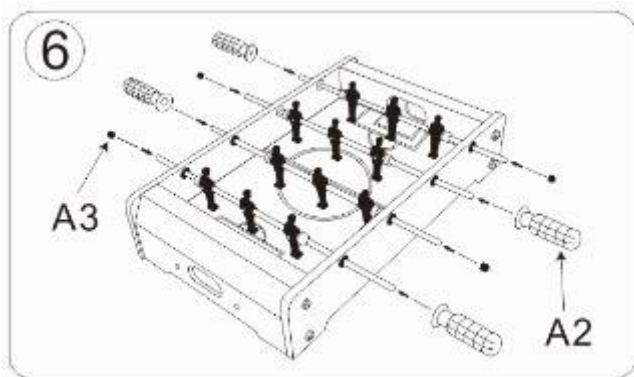

Umiestnite konce a 6 úchytiak na rukoväte a potom sa uistite, že každá rukoväť pevne sedí.

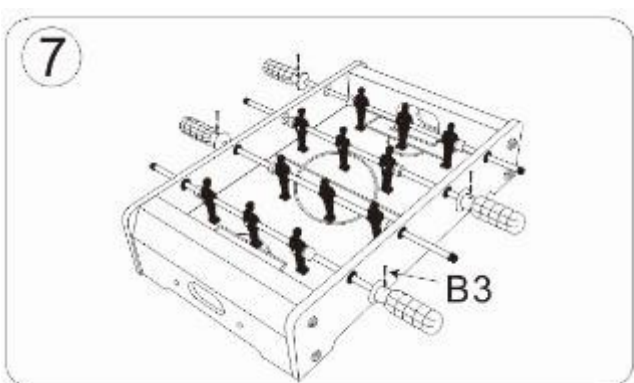

Do úchytiak vložte 6 hmoždínok a potom ich priskrutkujte.

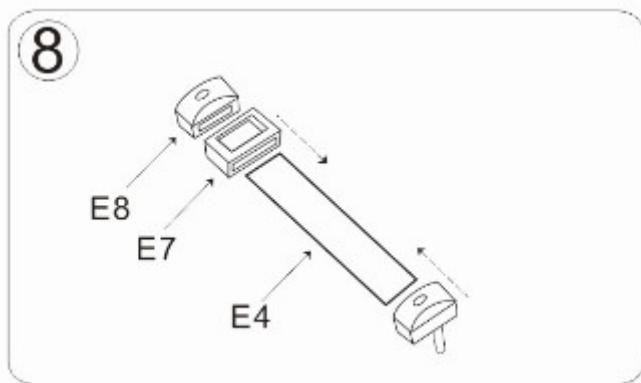

Upevnite diely v spodnej časti obrázka.

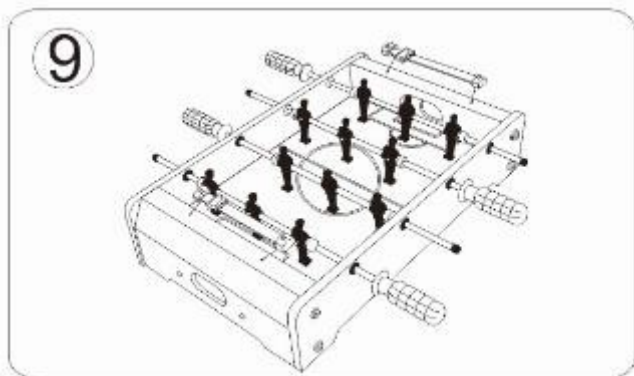

Umiestnite značky výsledkov na oba konce tabuľky.

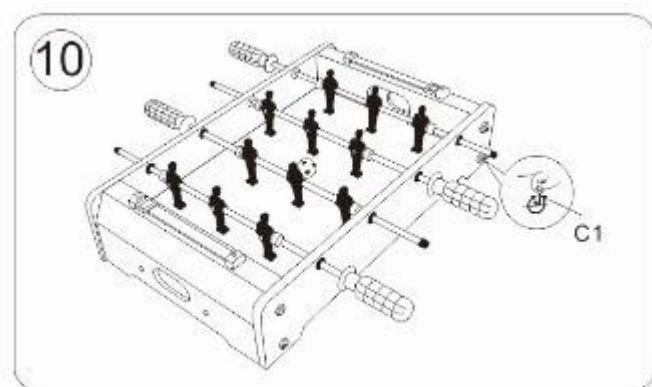

Uistite sa, že je všetko zmontované tak, ako má, a že je stôl stabilný, a nakoniec nasadíte na skrutky krycie matice.